

Robert M. Timm
Superintendent and Extension
Wildlife Specialist
Hopland Research and
Extension Center
University of California
Hopland, California 95449

NORWAY RATS

Fig. 1. Norway rat, *Rattus norvegicus*



Damage Prevention and Control Methods

Exclusion

Seal all openings larger than 1/2 inch (1.3 cm) wide.

Habitat Modification

Good sanitation practices reduce sources of food, water, and shelter.

Store foodstuffs in rodent-proof structures or containers.

Store and dispose of refuse and garbage properly.

Control weeds and remove debris from around structures.

Frightening

Ultrasonic devices have not been proven to control rats.

Repellents

Ro-pel®.

Toxicants

Anticoagulant rodenticides (slow-acting chronic-type toxicants)
Brodifacoum (Talon®).
Bromadiolone (Maki®, Contrace®).
Chlorophacinone (RoZol®).
Diphacinone (Ramik®, Ditrac®).
Pindone (Pival®, Pivalyn®).
Warfarin (Final® and others).

Toxicants other than anticoagulants (may be acute or chronic toxicants)
Bromethalin (Assault®, Vengeance®).
Cholecalciferol (Quintox®).
Red Squill.
Zinc phosphide (Ridall Zinc®, ZP® rodent bait).

Fumigants

In some situations, outdoor burrow fumigation may be effective.
Aluminum phosphide (Phostoxin® and others).
Chloropicrin.
Gas cartridges.
Methyl bromide.

Trapping

Snap traps.

Live traps.

Glue boards.

Other Methods

Clubbing.

Shooting.

Dogs and cats are of limited value in some situations.



PREVENTION AND CONTROL OF WILDLIFE DAMAGE — 1994

Cooperative Extension Division
Institute of Agriculture and Natural Resources
University of Nebraska - Lincoln

United States Department of Agriculture
Animal and Plant Health Inspection Service
Animal Damage Control

Great Plains Agricultural Council
Wildlife Committee

Field Identification of Domestic Rodents

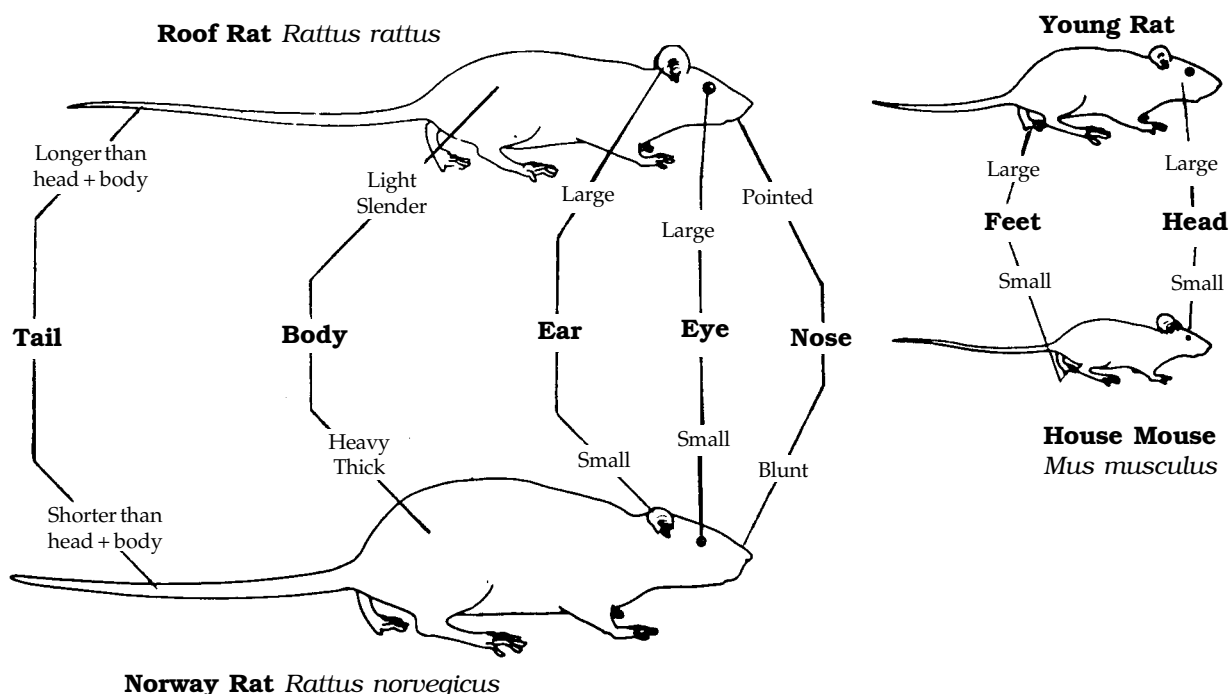

Fig. 2. Characteristics of commensal rodents

Identification

The Norway rat (*Rattus norvegicus*, Fig. 1) is a stocky burrowing rodent, unintentionally introduced into North America by settlers who arrived on ships from Europe. Also called the brown rat, house rat, barn rat, sewer rat, gray rat, or wharf rat, it is a slightly larger animal than the roof rat (Fig. 2). Adult Norway rats weigh an average of 1 pound (454 g). Their fur is coarse and usually brownish or reddish gray above and whitish gray on the belly. Blackish individuals occur in some locations.

Range

First introduced into the United States around 1775, the Norway rat has now spread throughout the contiguous 48 states. It is generally found at lower elevations but may occur wherever humans live.

Habitat

Norway rats live in close association with people. In urban or suburban areas they live in and around residences, in cellars, warehouses, stores, slaughterhouses, docks, and in sewers. On farms they may inhabit barns, granaries, livestock buildings, silos, and kennels.

They may burrow to make nests under buildings and other structures, beneath concrete slabs, along stream banks, around ponds, in garbage dumps, and at other locations where suitable food, water, and shelter are present. Although they can climb, Norway rats tend to inhabit the lower floors of multistory buildings.

Food Habits

Norway rats will eat nearly any type of food. When given a choice, they select a nutritionally balanced diet, choosing fresh, wholesome items over stale or contaminated foods. They prefer cereal grains, meats and fish, nuts, and some types of fruit. Rats require

1/2 to 1 ounce (15 to 30 ml) of water daily when feeding on dry foods but need less when moist foods are available. Food items in household garbage offer a fairly balanced diet and also satisfy their moisture needs.

General Biology, Reproduction, and Behavior

Norway rats are primarily nocturnal. They usually become active about dusk, when they begin to seek food and water. Some individuals may be active during daylight hours when rat populations are high.

Rats have poor eyesight, relying more on their hearing and their excellent senses of smell, taste, and touch. They are considered color-blind. Therefore, for safety reasons, baits can be dyed distinctive colors without causing avoidance by rats, as long as the dye does not have an objectionable taste or odor.

Rats use their keen sense of smell to locate food items and to recognize

other rats. Their sense of taste is excellent, and they can detect some contaminants in their food at levels as low as 0.5 parts per million.

Norway rats usually construct nests in below-ground burrows or at ground level (Fig. 3). Nests may be lined with shredded paper, cloth, or other fibrous material. Litters of 6 to 12 young are born 21 to 23 days after conception. Newborn rats are hairless and their eyes are closed, but they grow rapidly. They can eat solid food at 2 1/2 to 3 weeks. They become completely independent at about 3 to 4 weeks and reach reproductive maturity at 3 months of age.

Females may come into heat every 4 or 5 days, and they may mate within a day or two after a litter is born. Breeding often peaks in spring and fall, with reproductive activity declining during the heat of summer and often stopping completely in winter, depending on habitat. These seasonal trends are most pronounced in more severe climates. The average female rat has 4 to 6 litters per year and may successfully wean 20 or more offspring annually.

Norway rats have physical capabilities that enable them to gain entry to structures by gnawing, climbing, jumping, swimming, and other tactics. For more detailed information on their physical abilities and the resulting need to design rodent-proof structures, see the chapter **Rodent-Proof Construction and Exclusion Methods**.

Studies indicate that during its daily activities, a rat normally travels an area averaging 100 to 150 feet (30 to 45 m) in diameter. Rats seldom travel farther than 300 feet (100 m) from their burrows to obtain food or water.

Rats constantly explore and learn about their environment, memorizing the locations of pathways, obstacles, food and water, shelter, and other elements in their domain. They quickly detect and tend to avoid new objects placed into a familiar environment. Thus, objects such as traps and bait stations often are avoided for several days or more following their initial placement. Place baits and bait stations

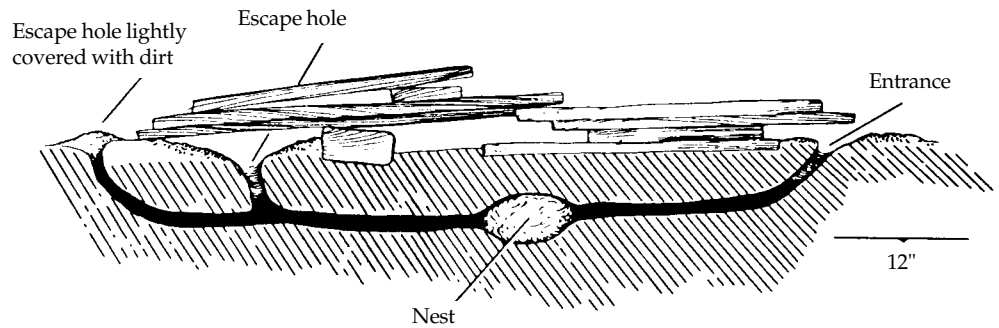

Fig. 3. Norway rat burrow system beneath a pile of boards.

near, but not on, rat runways. Rats will quickly find them and after a short period of avoidance, will cautiously investigate them. Baited but unset traps will aid in overcoming rats' fear of them; expanded-trigger traps set directly on travel routes may immediately catch rats.

Rats will at first avoid novel food items placed in their environment. They may eat very small amounts, and subsequent feeding will depend on the flavor of the food and its physiological effect. If the food contains poison or some other substance that soon produces an ill effect but not death, the food will often be associated with the illness. This "bait shyness" was a major problem when single-dose acute toxicants were the main rodenticides in use. Today, only two rodenticides registered for Norway rat control, red squill and zinc phosphide, possess characteristics that make bait shyness a potential problem.

Bait shyness can persist for weeks or months and may be transferred to nontoxic foods of similar types. Prebaiting, that is, training rats to feed repeatedly on nontoxic bait for a period of days prior to applying the toxicant in the bait, will largely prevent sublethal doses and thus bait shyness. It will also lead to successful control, with very few rats left to become bait-shy. Prebaiting will almost always increase control success when zinc phosphide or red squill baits are used.

Because anticoagulant rodenticides are slow-acting, the rats' subsequent illness is not associated with the bait even if a sublethal dose is consumed; thus, bait shyness does not usually

occur. These baits serve, in effect, as their own prebait.

Damage and Damage Identification

Norway rats consume and contaminate foodstuffs and animal feed. They may damage crops in fields prior to and during harvest, and during processing and storage. Rats also damage containers and packaging materials in which foods and feed are stored.

Rats cause structural damage to buildings by burrowing and gnawing. They undermine building foundations and slabs, cause settling in roads and railroad track beds, and damage the banks of irrigation canals and levees. Rats also may gnaw on electrical wires or water pipes, either in structures or below ground. They damage structures further by gnawing openings through doors, window sills, walls, ceilings, and floors. Considerable damage to insulated structures can occur as a result of rat burrowing and nesting in walls and attics.

Among the diseases rats may transmit to humans or livestock are murine typhus, leptospirosis, trichinosis, salmonellosis (food poisoning), and ratbite fever. Plague is a disease that can be carried by a variety of rodents, but it is more commonly associated with roof rats (*Rattus rattus*) than with Norway rats.

Rat Sign

The presence of rats can be determined by a number of signs described below:

Droppings may be found along runways, in feeding areas, and near shelter. They may be as large as 3/4 inch (2 cm) long and 1/4 inch (0.6 cm) in diameter. Fresh droppings are soft in texture.

Tracks, including footprints or tail marks, may be seen on dusty surfaces or in mud (Fig. 4). A tracking patch made of flour can be placed in pathways overnight to determine if rodents are present.

Urine, both wet and dry, will fluoresce under ultraviolet light. Urine stains may occur along travelways or in feeding areas.

Runs or burrows may be found next to walls, along fences, next to buildings, or under bushes and debris. Rats memorize pathways and use the same routes habitually.

Smudge marks (rub marks) may occur on beams, rafters, pipes, and walls as a result of oil and dirt rubbing off rats' fur along frequently traveled routes (Fig. 5).

Gnawing may be visible on doors, ledges, in corners, in wall material, on stored materials, or other surfaces wherever rats are present. Fresh accumulations of wood shavings, insulation, and other gnawed material indicate active infestations. Size of entry holes (often 1 1/2 inches [4 cm] in diameter or less for mice, 2 inches [5 cm] or larger for rats) or tooth marks can be used to distinguish rat from mouse gnawing. Rats keep their paired incisor teeth, which grow continuously at the rate of about 5 inches (13 cm) per year, worn down by gnawing on hard surfaces and by working them against each other.

Sounds such as gnawing, climbing in walls, clawing, various squeaks, and fighting noises are common where rats are present, particularly at times of the day when they are most active.

Estimating Rat Numbers

Rat sign and visual sightings are of limited value in accurately estimating rat numbers, but they are the simplest and often the only practical method

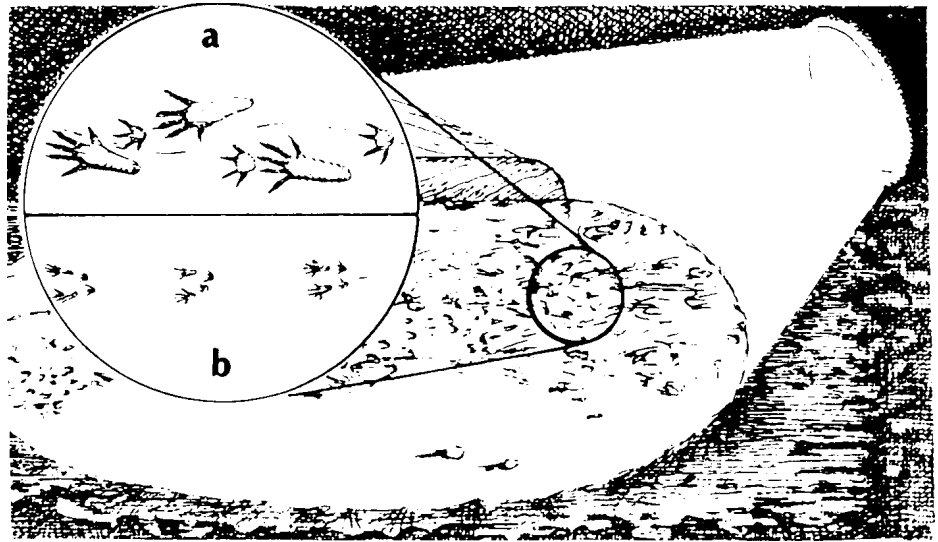

Fig. 4. Tracks left in dust by (a) Norway rat and (b) house mouse.

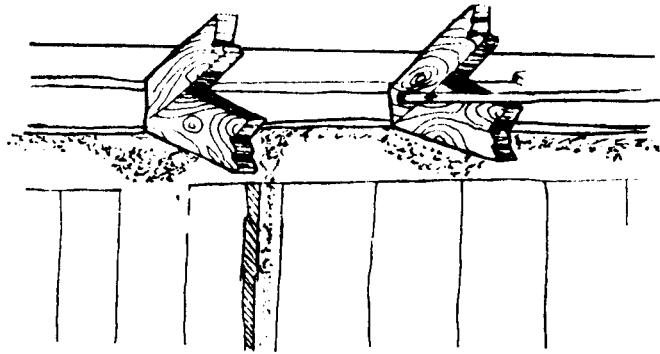

Fig. 5. Rub marks along beams, rafters, or other travel routes are evidence of rat activity.

available. Search premises thoroughly when looking for rats. In structures, searches should include attics, basements, around foundations, crawl spaces, and behind and under stored materials. The following estimates can then be made:

No sign: no rats or few present. If only a few rats are present they may have invaded only recently.

Old droppings and gnawing common, one or more rats seen by flashlight at night, or no rats observed in daytime: medium numbers present.

Fresh droppings, tracks, and gnawing present, three or more rats seen at night, or rats seen in daytime: large numbers present.

Since rats are normally nocturnal and somewhat wary of humans, usually many more rats are present than will be seen in the daytime. Under certain conditions, rats may become quite bold in the presence of humans, and then a high percentage of the population may be visible.

A conservative estimate of rat numbers can be made from measuring their food consumption. You can do this by feeding the rats for a while on finely ground grain (whole grains or pelleted foods may be carried off uneaten). When offered over a period of time, the ground grain will usually be accepted and eaten by rats. Consumption may gradually increase to a maximum level over the period of a

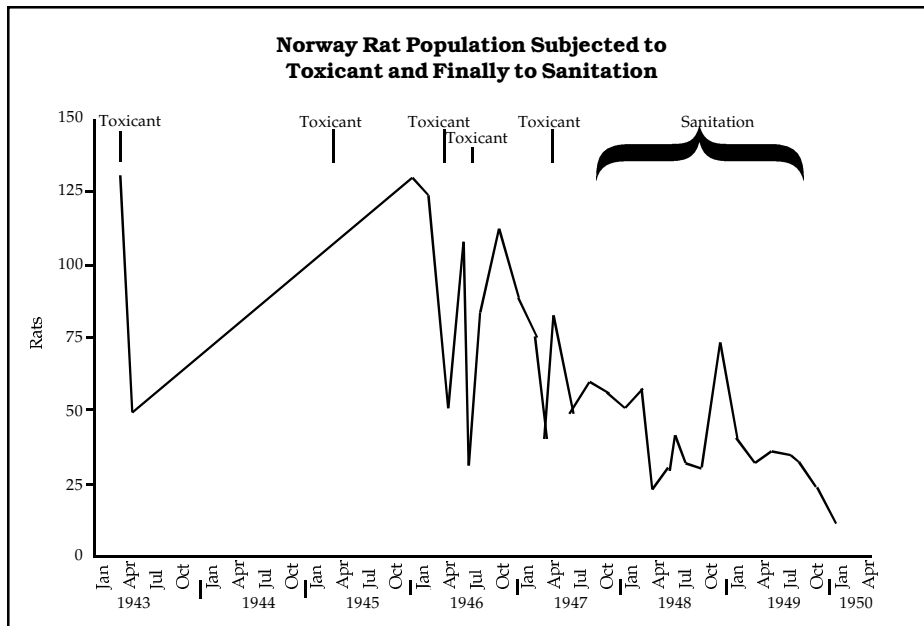

Fig. 6. Where repeated use of toxicants did not give lasting control, the use of sanitation (reduction of rats' food and shelter) assisted in reducing rat numbers.

week or so as the rats' natural fear of novel foods is overcome. Divide the total amount of food eaten per day by 1/2 ounce (15 g); this will give a minimum estimate of the rats present. Some rats eat more than 1/2 ounce (15 g) daily, but rats will probably also be using other foods in their environment. If too much alternative food is available, this technique will not give an adequate estimate.

Legal Status

Norway rats are not protected by law. They may be controlled with any pesticide registered by federal or state authorities for this purpose, or they may be controlled by use of mechanical methods such as traps.

Damage Prevention and Control Methods

Exclusion

Physical barriers can prevent rats from gaining entry to structures where food and shelter are available. "Rat-proofing" is an important and often neglected aspect of rat control. It is a relatively permanent form of rodent control that prevents damage from occurring.

To exclude rats, seal all holes and openings larger than 1/2 inch (1.3 cm) across. Rodent-proofing should be done with heavy materials that will resist rodent gnawing. These include concrete mortar, galvanized sheet metal, and heavy-gauge hardware cloth.

For more detailed information on rodent-proofing techniques, see the chapter **Rodent-Proof Construction and Exclusion Methods**.

Habitat Modification

In addition to the above-mentioned techniques of excluding rodents from sources of food and shelter, sanitation can play an important role in controlling rat populations (Fig. 6). Poor sanitation is one of the basic reasons for the continued existence of moderate to high rat populations in urban and suburban areas. In agricultural environments, proper sanitation cannot always eliminate rat populations, but it can often prevent rats from flourishing in large numbers.

Sanitation involves good housekeeping, including proper storage and handling of food materials, feed, and edible garbage. Warehouses, granaries and grain mills, silos, port facilities, and similar structures may provide excellent habitat for rats. Store bulk

foods in rodent-proof containers or rooms. Stack sacked or boxed foods in orderly rows on pallets in a way that allows thorough inspection for evidence of rats. In such storage areas, keep stored materials away from walls. A 12-inch (30-cm) white band painted on the floor adjacent to the wall will aid in detecting rodent droppings and other rat sign (Fig. 7). Sweep floors frequently to permit ready detection of fresh sign.

Pet foods often are a source of food for rats in and around homes. Keep all such materials stored in metal rodent-proof containers. Feed pets only what they will eat at a single time.

Garbage and rubbish from homes, restaurants, farms, and other such sources should be properly stored and subsequently removed for disposal. A proper refuse storage container is heavy-duty, rust-resistant, rat- and damage-resistant, and equipped with a tight-fitting lid. Galvanized steel trash containers in good condition are better than those made of vinyl or plastic. Racks or stands prevent corrosion or rusting of containers, reduce rat shelter under containers, and minimize the chance of containers being overturned (Fig. 8).

Bulk storage containers for refuse, such as those used at apartments, businesses, and housing projects, should be similarly rodent-proof. Large metal refuse containers (dumpsters) sometimes have drain holes to facilitate cleaning. These drain holes should be fitted with a wire mesh screen or a removable plug; otherwise, the container becomes a huge feeding station for rodents (Fig. 9).

Refuse should be collected regularly and before refuse storage containers become filled to excess. Sanitary landfills and incinerators seldom have conditions that will allow rat populations to exist. On the other hand, open refuse dumps are often infested by Norway rats. At a properly operated sanitary landfill, garbage and rubbish are compacted and covered with earth daily. Modern incinerators completely burn refuse, and the resulting residue does not provide food for rats.

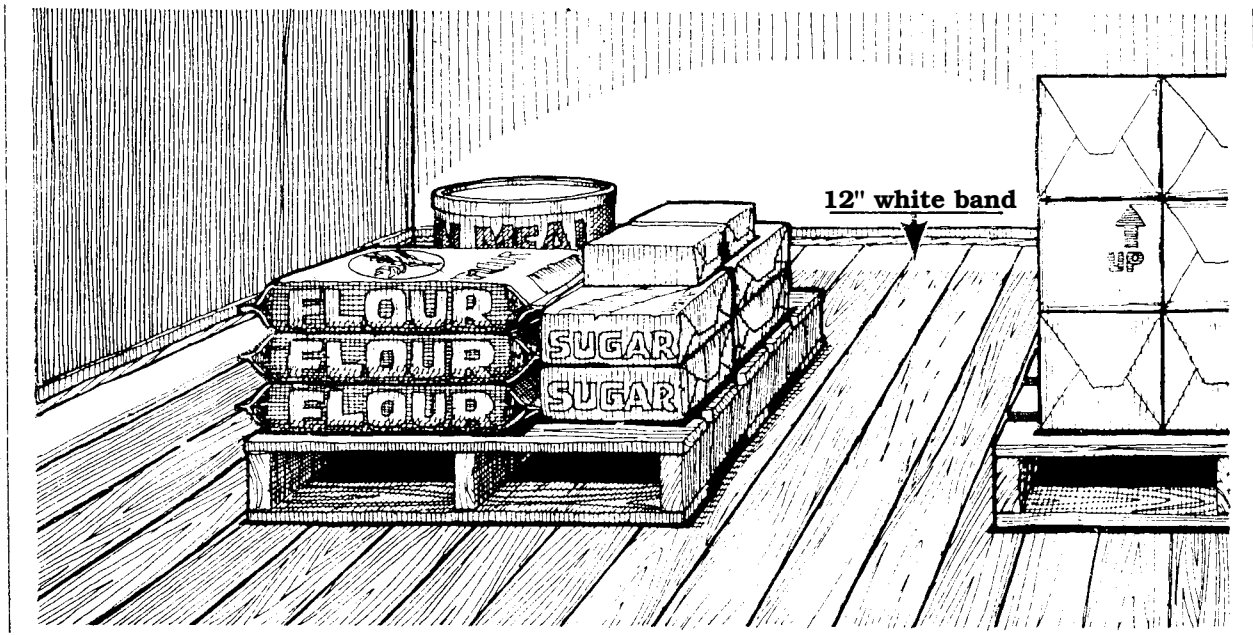

Fig. 7. A 12-inch (30-cm) white painted band makes inspection for rodent sign easier and reminds personnel to practice good sanitation.

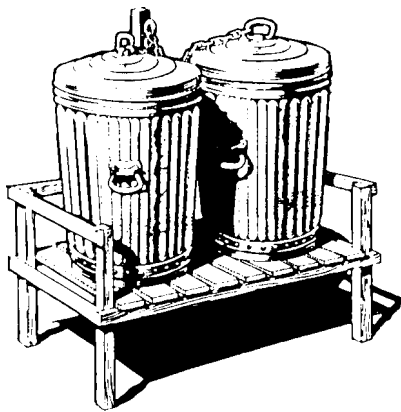

Fig. 8. Sturdy refuse containers on racks eliminate a source of food and shelter for rats.

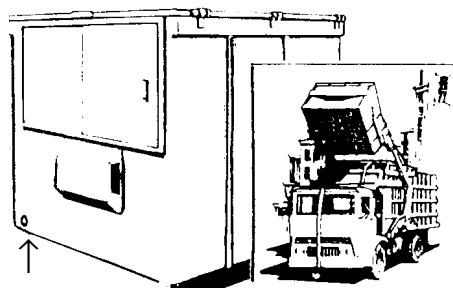

Fig. 9. Large metal refuse bins often have drainage holes (arrow). These should be plugged or screened to prevent rodent entry.

Sewers are inhabited by Norway rats in some towns and cities. Rats may enter at outlets and through manholes, catch basins, broken pipes, or drains. Since Norway rats are excellent swimmers, water traps do not impede their movement; in fact, they can travel upstream against a current. The problem of rats in sewers is usually greatest in places where sanitary sewers are interconnected with storm sewers, thus providing multiple entry points for rats. The domestic sewage of an average community provides enough food to sustain a large number of rats; this problem has increased as a result of the recent prevalence of garbage disposal units in most newer homes.

Regular removal of debris and control of weeds from around structures will reduce the amount of shelter available to rats. In some instances, a strip of heavy gravel placed adjacent to building foundations or other structures will reduce rat burrowing at these locations. Gravel should be at least 1 inch (2.5 cm) in diameter and laid in a band at least 2 feet (0.6 m) wide and 1/2 foot (15 cm) deep. In any event, keep the perimeter of buildings and other structures clean of weeds and debris (including stacked lumber, firewood, and other stored materials) to

discourage rat activity and to allow easier detection of rat sign.

Frightening

Rats are wary animals and can be frightened easily by unfamiliar sounds or sounds coming from new locations. Most rodents, however, can quickly become accustomed to new sounds heard repeatedly. For years, devices that produce ultrasonic sound that is claimed to control rodents have come and gone on the market. There is little evidence to suggest that rodents' responses to nonspecific, high-frequency sound is any different from their response to sound within the range human of hearing.

What is known about rodents and sound?

— Unusually loud, novel sounds, including ultrasonic sounds, which rats can hear, will frighten them and may cause temporary avoidance lasting from a few minutes to weeks or months.

What is known about ultrasonic sound?

— It is very directional and does not travel around corners well; thus, sound shadows or voids are created.

— Ultrasound does not travel very far. It loses its intensity rapidly as it leaves the source.

— Ultrasound has not been shown to drive established rodents out of buildings or areas, nor has it been proven to cause above-normal mortality in their populations. While it is possible to cause convulsions or permanent physiological damage to rodents with ultrasound, the intensity of such sounds must be so great that damage to humans or domestic animals would also be likely. Commercial ultrasonic pest control devices do not produce sound of such intensity.

Tests of commercial ultrasonic devices have indicated that rats may be repelled from the immediate area of the ultrasound for a few days, but then will return and resume normal activities. Other tests have shown the degree of repellency to depend upon the particular ultrasonic frequencies used, their intensity, and the preexisting condition of the rodent infestation.

Ultrasonic sound has very limited usefulness in rodent control. The advertising claims for many commercial devices are unsubstantiated by scientific research. Since commercial ultrasonic devices are often expensive and of questionable effectiveness, they cannot be recommended as a solution to rodent problems.

Repellents

Rats find some types of tastes and odors objectionable, but chemical repellents are seldom a practical solution to rat infestations. Substances such as moth balls (naphthalene) or household ammonia, in sufficient concentration, may have at least temporary effects in keeping rats out of certain enclosed areas. The above materials, however, are not registered by the EPA as rat repellents.

Ro-pel® is registered for use in repelling Norway rats and other rodents from gnawing on trees, poles, fences, shrubs, garbage, and other objects. Little information is currently available on its effectiveness against rats.

Other solutions to rat problems, including rodent-proof construction and methods of population reduction, are usually more permanent and cost-effective.

Toxicants

Rodenticides were formerly classified into two groups, single-dose (acute) toxicants and multiple-dose (chronic) rodenticides. However, the complexity in mode of action of newer rodenticides makes these classifications outdated. A classification into two groups, the first including all anticoagulants, and the second all other

compounds (“non-anticoagulants”), is currently more useful.

Anticoagulants (slow-acting, chronic toxicants). The anticoagulant rodenticides have been the most preferred materials for controlling rats since their initial development following World War II. They are quite acceptable to rats, do not cause bait shyness, are easy to apply, and if used properly, are relatively safe to use around livestock, pets, and humans.

Rats poisoned with anticoagulants die from internal bleeding, the result of loss of the blood’s clotting ability and damage to the capillaries. Animals killed by anticoagulants may show extreme lack of color of the skin, muscles, and viscera. Hemorrhage may be found in any part of the body. Prior to death, the animal exhibits increasing weakness due to blood loss.

Several anticoagulant compounds are registered for controlling Norway rats (Table 1). With the exception of two (bromadiolone and brodifacoum), multiple feedings over a period of several days are usually required to cause death. Relatively low, chronic doses are fatal, whereas the same amount of toxicant ingested at a single feeding may produce no significant effect to the rodent. However, this may vary for different anticoagulants. Feeding

Table 1. Anticoagulants used for Norway rat control in the United States.

Common name and typical trade names	Chemical name	Usual types of formulations			Percent active ingredient used in food bait
		Food Bait	Liquid	Tracking Powder	
<i>Hydroxycoumarins</i>					
Warfarin (Final® and others)	3-(α -acetonylbenzyl)-4-hydroxycoumarin	X	X		0.025
Brodifacoum (Talon®)*	3-[3(4'-bromo[1,1'biphenyl]-4-yl)-1,2,3,4-tetrahydro-1-naphthalenyl]-4-hydroxy-2H-1-benzopyran-2-one	X			0.005
Bromadiolone (Maki®, Contrac®)*	3-[3-(4'-bromo[1,1'biphenyl]-4-yl)-3-hydroxy-1-phenylpropyl]-4-hydroxy-2H-1-benzopyran-2-one	X			0.005
Difethialone*	[(bromo-4'-0[biphenyl-1-1']yl-4)3-tetrahydro-1,2,3,4-naphthyl-1]3-hydroxy-4,2H-1-benzo-thiopyran-2-one	X			0.0025
<i>Indandiones</i>					
Chlorophacinone (RoZol®)	2-[(p-chlorophenyl)phenylacetyl]-1,3-indandione	X		X	0.005
Diphacinone (Ramik®, Ditrac®)	2-diphenylacetyl-1,3-indandione	X		X	0.005
Pindone (Pival®, Pivalyn®)	2-pivalyl-1,3-indandione	X	X		0.025

*Second-generation anticoagulants especially useful for the control of warfarin-resistant rats and mice.

does not always have to be on consecutive days. When anticoagulants are eaten daily, however, death may occur as early as the third or fourth day. For optimal lethal effects, several feedings should occur within a 10-day period with no longer than 48 hours between feedings.

All anticoagulants provide good to excellent Norway rat control when prepared in acceptable baits. A new second-generation anticoagulant, difethialone, is presently being developed and EPA registration is anticipated in the near future. The characteristics of the various anticoagulant rodenticides are described further in the **Pesticides** section.

Because of their similarity in mode of action, all anticoagulant baits are used in a similar fashion. Label directions commonly instruct the user to “maintain a continuous supply of bait for 15 days or until feeding ceases,” thus ensuring that the entire rat population has ample opportunity to ingest a lethal dose of the bait. Anticoagulants have the same effect on nearly all warm-blooded animals, but the sensitivity to these toxicants varies among species. If misused, anticoagulant rodenticides can be lethal to nontarget animals such as dogs, pigs, and cats. Additionally, residues of anticoagulants which are present in the bodies of dead or dying rodents can cause toxic effects to scavengers and predators. In general, however, the secondary poisoning hazard from anticoagulants is relatively low.

Brodifacoum and bromadiolone baits, because of their potential to be lethal in a single feeding, can be more effective than the other anticoagulants in certain situations.

Chlorophacinone (RoZol®) and diphacinone (Ramik®, Ditrac®) are similar in potency and are more toxic than the anticoagulant compounds developed earlier. Thus, they are formulated at lower concentrations. Chlorophacinone and diphacinone may kill some rats in a single feeding, but multiple feedings are needed to give adequate control of an entire rat population.

Pindone (Pival®, Pivalyn®) is also less potent than chlorophacinone or diphacinone, and it is regarded as slightly less effective than warfarin against Norway rats. It has some properties that resist insects and growth of mold in prepared baits.

Warfarin (Final® and other trade names) was the first marketed anticoagulant and therefore became the best known and most widely used. It is effective against Norway rats, although some products may contain small quantities of contaminants that apparently can reduce bait acceptance. This problem was resolved by the development of micro-encapsulated warfarin.

Anticoagulant Resistance. Within any population of Norway rats, some individuals are less sensitive to anticoagulants than others. Where anticoagulants have been used over long periods of time at a particular location, there is an increased potential for the existence of a population that is somewhat resistant to the lethal effects of the baits. Such resistant populations of rats have been identified at a number of locations throughout the United States. Although not common, resistance may be underestimated because documentation of resistance is usually not pursued by persons involved in operational rat control programs.

Resistance, if and when it occurs, is of little consequence in the control of Norway rats, especially with the newer rodenticides presently available. When anticoagulant resistance to the first-generation anticoagulants is known or suspected, use of these compounds should be avoided in favor of the second-generation anticoagulants or one of the non-anticoagulant products.

Anticoagulant Bait Failure. Resistance is only one (and perhaps the least likely) reason for failure in the control of rats with anticoagulant baits. Control with baits that are highly accepted may fail for one or more of the following reasons:

— Too short a period of bait exposure.

- Insufficient bait and insufficient replenishment of bait (none remains from one baiting to the next).
- Too few bait stations and/or too far apart. In some situations, stations may have to be within 20 to 30 feet (7 to 10 m) of one another.
- Too small a control area, permitting rats to move in from untreated adjacent areas.
- Genetic resistance to the anticoagulant. Although this is unlikely, it should be suspected if about the same amount of bait is taken daily for a number of weeks.

Control with anticoagulant baits that are poorly accepted may fail for one or more of the following reasons:

- Poor bait choice, or bait is formulated improperly. Other foods are more attractive to the rats.
- Improperly placed bait stations. Other foods are more convenient to the rats.
- Abundance of other food choices.
- Tainted bait: the bait has become moldy, rancid, insect-infested, or contaminated with other material that reduces acceptance. Discard old bait periodically, and replace it with fresh bait.

Occasionally, rats accept bait well and an initial population reduction is successful. Then bait acceptance appears to stop although some rats remain. In such instances it is likely that the remaining rats never accepted the bait either because of its formulation or placement. The best strategy is then to switch to a different bait formulation, place baits at different locations, and/or use other control methods such as traps.

Other Rodenticides. The older rodenticides, formerly referred to as acute toxicants, such as ANTU, arsenic trioxide, phosphorus, and Compound 1080, are no longer registered for rat control. The widespread availability of ready-to-use anticoagulants and their relative effectiveness have resulted in the reduced use of these older materials over the last 20 years.

Table 2. Other (non-anticoagulant) rodenticides used to control Norway rats in the United States.

Common Name	Chemical Name	Acute oral LD ₅₀ for rats mg/kg	Time to death	Odor	Taste	Percent active ingredient in food bait	Relative Hazard	Mode of Action
Bromethalin (Assault®, Vengeance®)	N-methyl-2,4-dinitro-N-(2,4,6-tribromophenyl)-6-(trifluoromethyl)benzenamine	2-5	2-4 days	None	Slight	0.01	Moderate	Central nervous system depression and paralysis
Cholecalciferol (Quintox®, vitamin D ₃)	9,10-Seocholesta-5,7,10 (19)-trein-3 betaol	10-50	3-4 days	Slight	None	0.075	Low to moderate	Mobilizes calcium resulting in death from hypercalcemia
Red squill	scilliroside glycoside*	200-490	< 24 hrs.	Medium	Strong	10	Low	Heart
Zinc phosphide	zinc phosphide	27-40	1/2-20 hours	Strong	Strong	1.0-2.0	Moderate	Phosphine gas enters circulatory system; heart paralysis, gastrointestinal and liver damage

* principal active ingredient

At present, four non-anticoagulant rodenticides (Table 2) are registered by EPA against Norway rats: bromethalin, cholecalciferol (vitamin D₃), red squill, and zinc phosphide. All are potentially useful for controlling anticoagulant-resistant populations of rats.

Of these active ingredients, bromethalin and cholecalciferol are formulated to serve as chronic rodenticides, applied so that rats will have the opportunity to feed on the baits one or more times over the period of one to several days. Bait acceptance is generally good when formulations appropriate for rats are selected. Zinc phosphide and red squill differ in that prebaiting (offering rats similar but nontoxic bait prior to applying the toxicant-treated bait) is recommended to increase bait acceptance. These two rodenticides are not designed to be left available to rats for more than a few days, as continued exposure is likely to result in bait shyness within the population. Be sure to follow label recommendations on any specific product to achieve best success.

Non-anticoagulant rodenticides, particularly zinc phosphide, remain useful tools to achieve quick reductions in rat populations. When rat numbers are large, the cost of baiting with these materials may be lower than for the anticoagulants.

Bromethalin (Assault®, Vengeance®) is formulated in a ready-to-use bait as a chronic rodenticide, applied so that rats will have the opportunity to feed on the bait one or more times over a period of one to several days. Because it is a slow-acting in comparison to zinc phosphide or red squill, bait shyness is not usually a problem, nor is prebaiting necessary to get good control in most situations.

Cholecalciferol (vitamin D₃, Quintox®) is similarly formulated in a ready-to-use bait, serving as a chronic rodenticide. Death occurs 3 or 4 days after ingestion of a lethal dose. Because the toxicant is slow-acting, bait shyness is not reported to occur. It is claimed that rodents cease feeding once a lethal dose has been ingested.

Red squill is a relatively selective and safe toxicant for use only against Norway rats. It acts as an emetic, which provides some degree of protection to certain nontarget species that might accidentally consume the bait. Rats, which cannot vomit, are unable to rid themselves of the toxicant once it is consumed. In the past, one problem was the variation in the quality of the material, which is derived from a plant. Red squill must be stored in a sealed container, as moisture will cause loss of potency.

Zinc phosphide is a dark gray powder, insoluble in water, that has been used extensively in the control of rodents. It is available in ready-to-use dry baits and also in concentrates for use by persons trained in rodent control who may wish to prepare their own baits. Its strong garlic-like odor appears to be attractive to rodents that are not bait-shy. Oils and fats make excellent binders for zinc phosphide and increase absorption of the toxicant when ingested. An effective bait is made from mixing zinc phosphide with meat such as canned fish-flavored cat food. Rats will readily accept this bait, especially if adequate prebaiting has been done beforehand.

The following general steps are recommended to obtain good bait acceptance, and therefore good rat control, when using zinc phosphide baits:

1. Prebait rats for a minimum of 3 to 5 days to get the rats accustomed to eating the nontoxic bait material. Do not change types of bait during the prebaiting or baiting operation. Apply prebait at many locations, wherever there is rat activity. Where bait is completely eaten overnight, double the amount of prebait at that location the next day. Repeat this procedure until the amount of bait eaten every night no longer increases.

2. Use only high-quality grains and fresh ready-to-use baits. Where rats have access to abundant amounts of grain, meat such as canned fish-flavored cat food may be a good substitute. Obtain a sufficient quantity to complete the project without changing brands or flavors.
3. Wait until prebait consumption has peaked before applying toxic baits. Remove any uneaten prebait and place the toxic bait at the same locations that the prebait was applied. Usually, the amount of toxic bait needed will be about half the amount used on the last day that prebait was applied. It may be helpful to wait one day between the last application of prebait and application of toxic bait. That way, rats will be hungrier. Mix the toxicant into the bait ingredients according to label directions, if preparing your own baits from a concentrate.
4. Avoid handling the toxic bait or rodenticide concentrate with bare hands; use rubber or latex gloves. Clean thoroughly any tools or containers used in bait mixing, or safely dispose of them as well as bait packaging materials.
5. Confine or restrain any pets, livestock, or other animals that may otherwise gain access to and feed on the bait. It may also be necessary to place prebait and toxic bait into bait boxes for safety.
6. Following toxic bait application, pick up and dispose of available dead rats and all uneaten bait by incineration or deep burial. Normally, bait should be exposed for only 1 or 2 nights; the greatest consumption occurs on the first night.
7. Control remaining rats by using anticoagulant baits or by using traps or burrow fumigants.

Bait Selection and Formulation

Contrary to popular belief, rats prefer fresh, high-quality foods and will reject spoiled or inferior foods item when given a choice. Therefore, rodent baits should be made from high-quality food materials.

Usually corn, oats, wheat, or barley are the grains most preferred by Norway rats. Preference will vary between rat populations and among individual rats. Baits similar to foods rats are accustomed to eating are often a good choice, particularly if their normal foods are limited or can be made less available to them. Some people trained in rodent control prefer to mix their own baits. Ground cereal grains are often mixed with 5% powdered sugar and 3% to 10% vegetable oil. A toxicant concentrate is added to this mixture in the proper amount. Certain anticoagulants, as well as zinc phosphide, can be purchased in concentrate forms for use in formulating baits. Under some conditions, baits made with fruits, vegetables, meat, or fish may be highly accepted. Use of such bait materials, however, may increase the risk of poisoning cats, dogs, domestic animals, and other nontarget species.

To determine bait preference in rats, conduct a bait-choice test by placing about 4 ounces (115 g) of each of several nontoxic baits about one foot (30 cm) apart in several locations where rats are present. Check baits for the next few days to find out which foods rats preferred. Keep in mind that rats are suspicious of new objects and novel foods; therefore, they may not accept a new bait until the third or fourth day.

The ready-to-use baits most available to the public are anticoagulant rodenticides. Several types are available. Grain-based baits in a loose meal or pelleted form are available in bulk or packaged in small, 4- to 16-ounce (112- to 454-g) plastic, cellophane, or paper "place packs" (Fig. 10). These packets keep bait fresh and make it easy to place baits into burrows, walls, or other locations. Rats will gnaw into these bags to feed on acceptable baits. Pelleted baits can more easily be carried by rats to other locations. Such hoarding of food by rats is not uncommon. It may result in amounts of bait being moved to places where it is undetected or difficult to recover and may, if accessible, be hazardous to nontarget species.

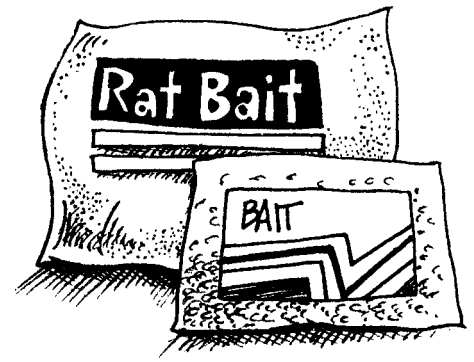

Fig. 10. Various types of place packs containing ready-to-use rodenticides are commercially available.

Anticoagulant baits have also been formulated into wax and extruded blocks (Fig. 11). These are particularly useful in sewers or where moisture may cause loose grain baits to spoil. Rats accept paraffin block baits less readily than loose or pelleted grain baits, but acceptance of extruded bait blocks is high.

Sodium salts of anticoagulants are available as concentrates to be mixed with water, making a liquid bait (Fig. 12). Since rats require water daily, they can be drawn to water stations where other water sources are scarce. Water baits are particularly useful in grain storage structures, warehouses, and other such locations. Rodents are more easily able to detect anticoagulants in water baits than in food baits; therefore, up to 5% sugar is sometimes added to liquid baits to increase rats' acceptance of the bait solution. Since water is attractive to most animals, use water baits in ways that prevent nontarget animals from drinking them.

Bait Stations

Bait stations (bait boxes) may increase both the effectiveness and safety of rodenticides. They came into general use after the development of the first-generation anticoagulants, which require that a continuous supply of bait be made available to rodents. Bait stations are useful because they:

- protect bait from moisture and dust;
- provide a protected place for rodents to feed, allowing them to feel more secure;

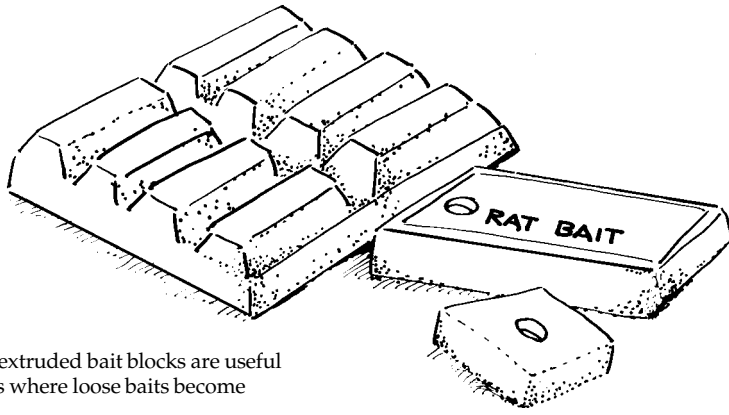

Fig. 11. Wax and extruded bait blocks are useful in damp locations where loose baits become spoiled quickly.

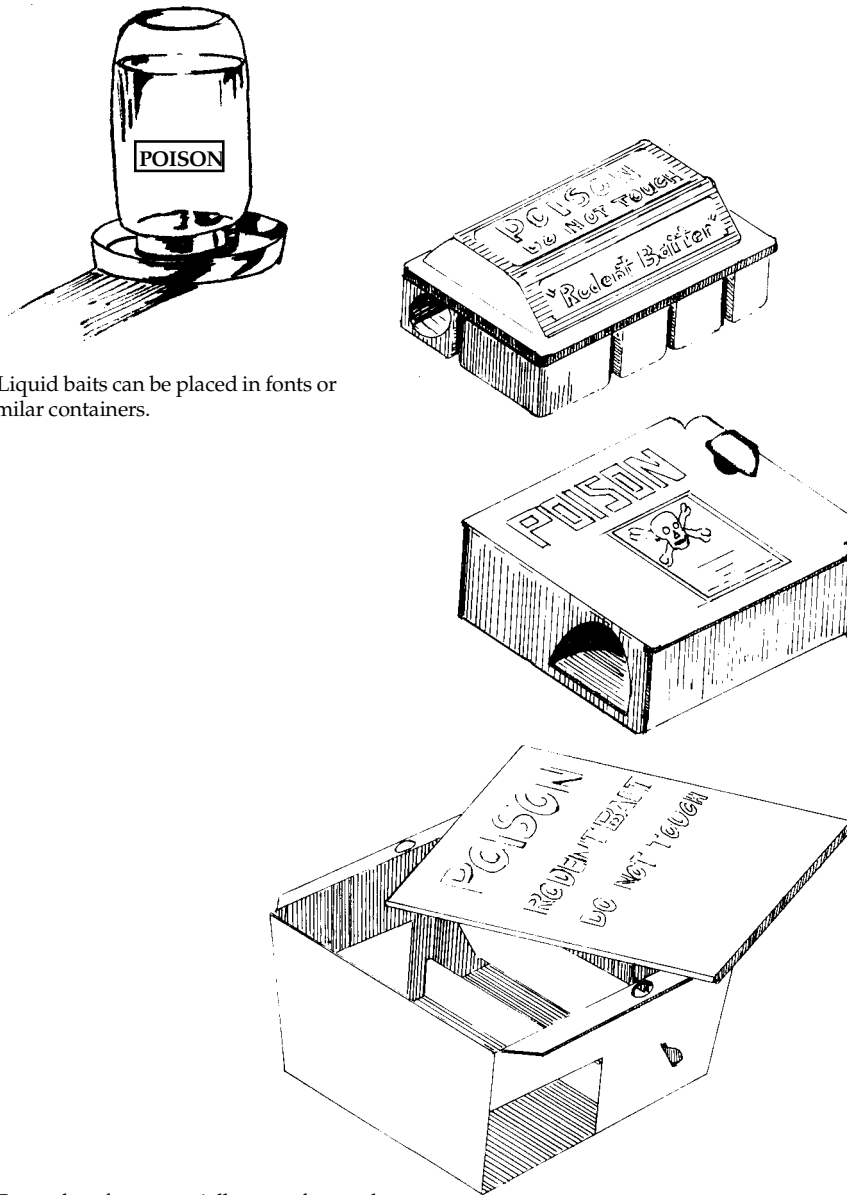

Fig. 12. Liquid baits can be placed in fonts or other similar containers.

Fig. 13. Examples of commercially manufactured rodent bait stations.

- keep other animals (pets, livestock, desirable wildlife) and children away from hazardous bait;
- allow placement of bait in locations where it would otherwise be difficult because of weather or potential hazards to nontarget animals;
- help prevent the accidental spilling of bait;
- allow easy inspection of bait to see if rodents are feeding on it.

Kinds of Bait Stations. Bait stations can contain solid baits liquid baits, or both. Bait boxes can be purchased from commercial suppliers or made at home. Manufactured bait boxes made of plastic, cardboard, or metal (Fig. 13) are sold to pest control companies and to the public in sizes for rats or mice. Some farm supply and agricultural chemical supply stores have them in stock or can order them.

Bait boxes can be built from scrap materials, and homemade stations can be designed to fit individual needs. Make them out of sturdy materials so they cannot be easily knocked out of place or damaged. Where children, pets, or livestock are present, be careful to construct the stations so that the bait is accessible only to rodents. Locks, seals, or concealed latches are often used to make bait boxes more tamperproof. In some situations, stations should be secured in place. Clearly label all bait boxes or stations with "Poison" or "Rodent Bait — Do Not Touch," or with a similar warning. Some rodenticides or situations may require use of tamper-resistant bait stations. If so, use only bait boxes or stations which are so designated, and also be sure to secure them to buildings by nailing or gluing them to walls or floors in a way that will not permit a person or animal to knock them over or shake the bait out.

Bait Station Design. Bait stations should be large enough to allow several rodents to feed at once. They can be as simple as a flat board nailed at an angle to the bottom of a wall (Fig. 14), or a length of pipe into which bait can be placed (Fig. 15). More elaborate stations are completely enclosed and can

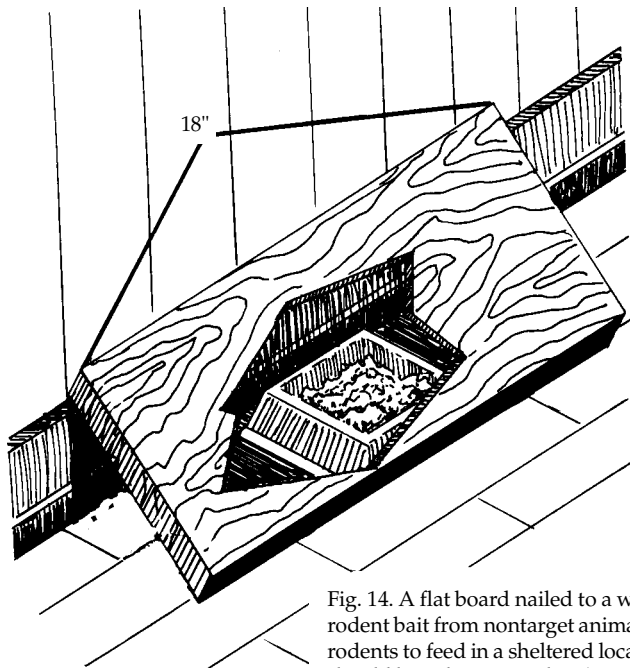

Fig. 14. A flat board nailed to a wall protects rodent bait from nontarget animals and allows rodents to feed in a sheltered location. The board should be at least 18 inches (46 cm) long to keep pets and children from reaching the bait.

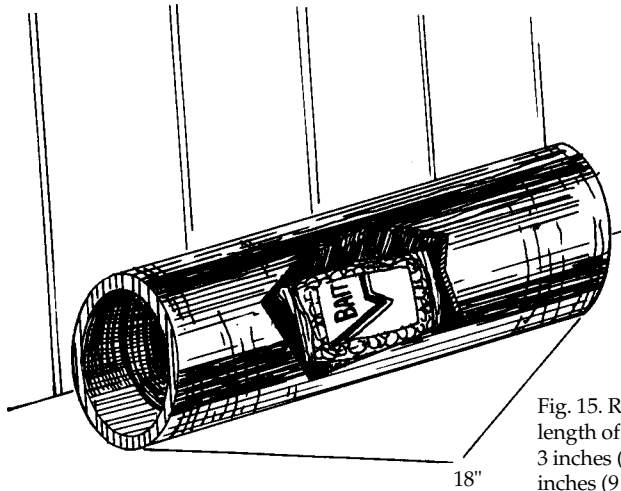

Fig. 15. Rodent bait station made from a length of pipe. Pipe diameter can be 2 to 3 inches (5 to 8 cm) for mice; 3 1/2 to 6 inches (9 to 15 cm) for rats.

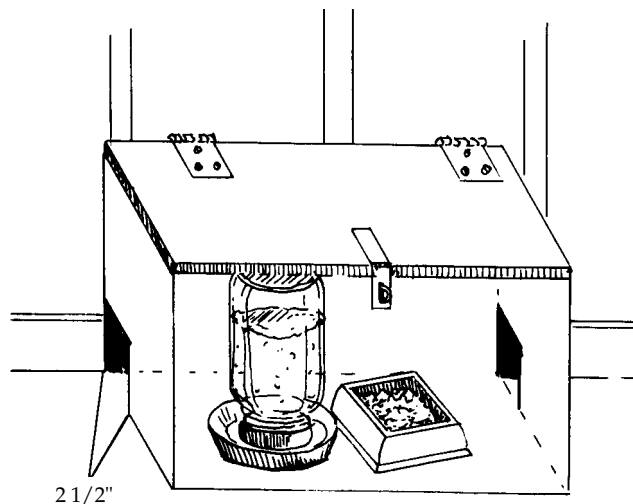

Fig. 16. A homemade rodent bait station can contain liquid as well as solid baits.

contain liquid as well as solid baits (Fig. 16). A hinged lid with a child-proof latch can be used for convenience in inspecting permanent stations.

Bait stations for rats should have at least two openings approximately 2 1/2 inches (6 cm) in diameter. The two holes should be on opposite sides of the station because rodents can see an alternate escape route as they enter the station.

Bait Station Maintenance. Baits must be fresh and of high quality. Rats will reject spoiled or stale foods. Provide enough fresh bait to allow rodents to eat all they want. When you first put bait boxes out, check them daily and add fresh bait as needed. After a short time, rodent numbers and feeding will decline, and you will need to check the boxes only every 2 weeks or once a month. If the bait becomes moldy, musty, soiled, or insect-infested, empty the box and clean it, and then refill it with fresh bait. Dispose of spoiled or uneaten bait in accordance with the label. Follow all label directions for the product you are using.

Placement of Bait Stations.

Proper placement of bait stations is just as important as bait selection. Rats will not visit bait stations, regardless of their contents, if they are not conveniently located in areas where rodents are active.

Where possible, place bait between the rodents' source of shelter and their food supply. Put bait boxes near rodent burrows, against walls, or along travel routes. Since rats are often suspicious of new or unfamiliar objects, it may take several days for them to enter and feed in bait stations.

On farmsteads, bait station placement depends on building design and use. In swine confinement buildings, it may be possible to attach bait boxes to wall ledges or the top of pen dividing walls. Bait boxes may be placed in attics or along the floors or alleys where rodents are active (Fig. 17). Rodent tracks visible on dusty surfaces and their droppings often give clues to where they are active.

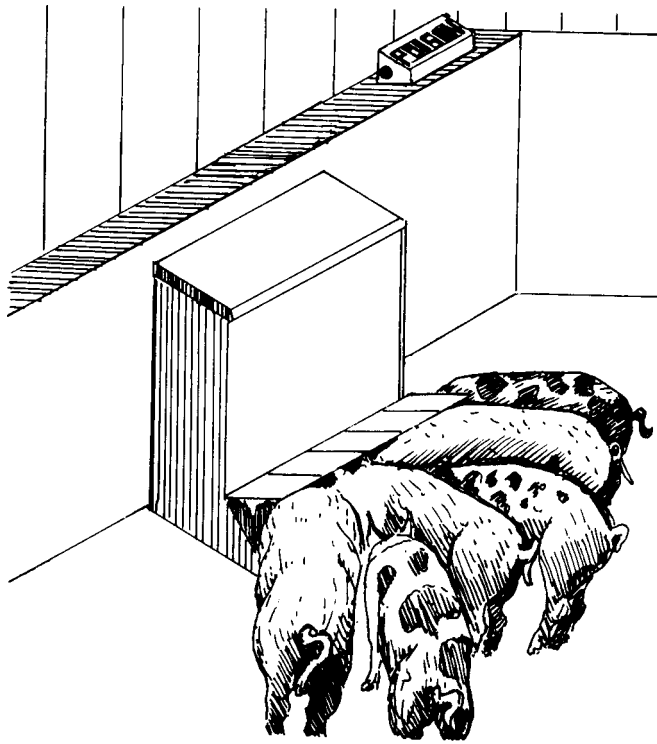

Fig. 17. Rodent bait box attached to the top of a pen dividing wall in a swine confinement facility. When used in such locations, bait boxes must be securely fastened and out of pigs' reach.

Never place bait stations where live-stock, pets, or other animals can knock them over. Spilled bait may be a potential hazard, particularly to smaller animals.

Where buildings are not rodent-proof, permanent bait stations can be placed inside buildings, along the outside of building foundations, or around the perimeter. Bait stations will help keep rodent numbers at a low level when maintained regularly with fresh anticoagulant bait. Rodents moving in from nearby areas will be controlled before they can reproduce and cause serious damage.

Tracking Powders. Toxic dusts or powders have been successfully used for many years to control rats and mice. When rodents walk through a patch of toxic powder, they pick some of it up on their feet and fur and later ingest it while grooming. Tracking powders are useful in controlling rats where food is plentiful and good bait acceptance is difficult to achieve. Rats are more likely to ingest a lethal amount of a poorly accepted toxicant applied by this method than if it is mixed into a bait material. There is little likelihood of toxicant shyness

developing when using tracking powders.

Because the amount of material a rat may ingest while grooming is small, the concentration of active ingredient in tracking powders is considerably higher than in food baits that utilize the same toxicant. Therefore, these materials can be more hazardous than food baits. For the most part, tracking powders are used by professional pest control operators and others trained in rodent control. Currently, the only tracking powders registered for use against Norway rats contain anticoagulants.

Place tracking powders in rat burrows, along runways, in walls, behind boards along walls, or on the floor of bait stations. Placement can be aided by using various types of sifters, shakers, or blowers. Dampness may cause the powder to cake and lessen its effectiveness. Care must be taken to place tracking powders only where they cannot contaminate food or animal feed, or where nontarget animals cannot come into contact with them. Do not place tracking powders where rats can track the material onto food intended

for use by humans or domestic animals. Tracking powders are not generally recommended for use in and around homes because of potential hazards to children and pets. Where possible, remove tracking powder after the rodent control program is completed.

Fumigants

Fumigants (toxic gases) are most commonly used to control rats in their burrows at outdoor locations. Compounds including aluminum phosphide, chloropicrin, and gas cartridges, are registered for this purpose. The incendiary gas cartridge burns, producing carbon monoxide and other gases that suffocate rodents in their burrows. Methyl bromide is presently registered only for fumigation of structures by qualified professionals. Anhydrous ammonia is not recommended for use as a burrow fumigant because it is not registered for this purpose. For further information on fumigants, see the **Pesticides** section.

Fumigants should only be used by people familiar with the necessary precautions because they are highly toxic to humans and other animals. Do not use fumigants in any situation that might expose the occupants of a building to the fumes. Only licensed structural pest control operators should use fumigants in buildings or other structures.

To fumigate rat burrows, close the burrow opening with soil or sod immediately after introduction of the fumigant. Rat burrows often have multiple entrances, and all openings must be sealed in order for fumigants to be effective. Fumigants are less effective in soils that are very porous or dry.

Trapping

Trapping can be an effective method of controlling rats, but it requires more skill and labor than most other methods. Trapping is recommended where toxicants are inadvisable. It is the preferred method to try first in homes, garages, and other small structures where there may be only a few rats present.

Trapping has several advantages: (1) it does not rely on inherently hazardous rodenticides; (2) it permits the user to view his or her success; and (3) it allows for disposal of the rat carcasses, thereby eliminating odor problems from decomposing carcasses that may remain when poisoning is done within buildings.

The simple, inexpensive, wood-based snap trap is available in most hardware and farm supply stores. Traps should be baited with a small piece of hot dog, bacon, or nutmeat tied securely to the trigger. Peanut butter or marshmallows also may be used as bait. Baits that become stale lose their effectiveness.

Set traps close to walls, behind objects, in dark corners, and in places where rat activity is seen. Place the traps so that when rats follow their natural course of travel (usually close to a wall) they will pass directly over the trigger (Fig. 18). Set traps so that the trigger is sensitive and will spring easily. Effectiveness can be increased by enlarging the trigger. Attach a square of cardboard, metal, or screen wire that fits just inside the wire deadfall (Fig. 19).

Leaving traps unset until the bait has been taken at least once reduces the chance of rats escaping the trap and becoming trap-shy. Other kinds of traps are also effective in catching rats. Wire-mesh cage traps such as the National®, Tomahawk®, and Havahart® can be used effectively to capture rats alive (Fig. 20). Wire funnel-entrance traps have also been used to capture rats alive.

Keep traps reasonably clean and in good working condition. They can be cleaned with a hot detergent solution and a stiff brush. Human and dead-rat odors on traps are not known to reduce trapping success.

An alternative to traps are glue boards, which catch and hold rats attempting to cross them, much the same way flypaper catches flies. Place glue boards wherever rats travel — along walls or in established runways. Do not use glue boards where children, pets, or desirable wildlife can contact them. Glue boards lose their effectiveness in dusty areas unless covered, and temperature extremes may affect the tackiness of some glues. They are considered less effective for capturing rats than for mice. Glue boards can be

purchased ready-to-use or they can be made. Euthanize live, trapped rodents by asphyxiation with carbon dioxide, or use a stick to kill them with sharp blows to the base of the skull. For further information on glue boards, see the **Supplies and Materials** section.

Other Methods

In some situations, rats can be killed manually with a club or other implement. When rats have access to a structure through only one or a few entrances, it may be possible to drive them out en masse. Then they can be clubbed or shot with a pellet gun or .22 firearm loaded with birdshot.

Some dogs and cats will catch and kill rats. There are few situations, however, in which they will do so sufficiently to control rat populations. Around most structures, rats can find many places to hide and rear their young out of the reach of such predators. Cats probably cannot eliminate existing rat populations, but in some situations they may be able to prevent reinfestations once rats have been controlled. Farm cats, if sufficient in number and supplementally fed, may serve this function.

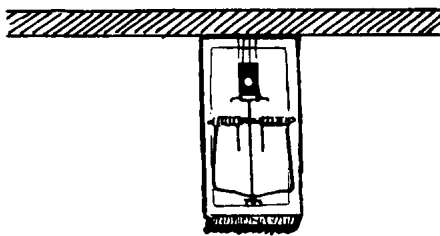

Single trap set with trigger next to wall.

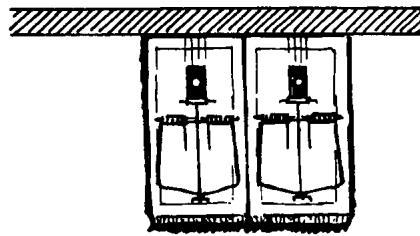

The double set increases your success.

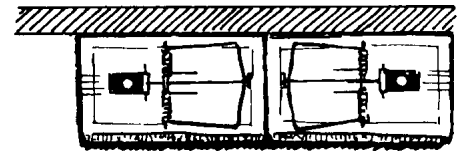

Double set placed parallel to the wall with triggers to the outside.

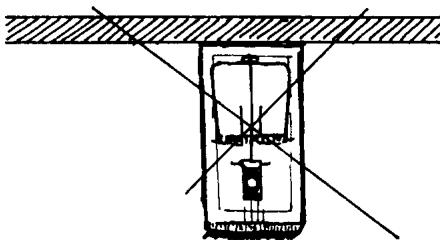

Wrong—trigger not next to wall.

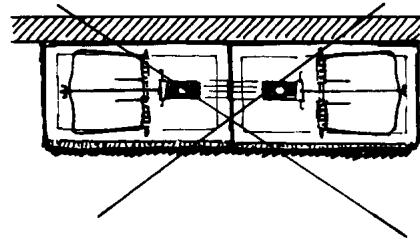

Wrong—parallel set with triggers on the inside.

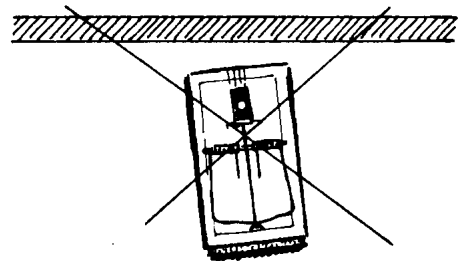

Wrong—trap too far from wall.

Fig. 18. Placement of snap traps

A box or board placed to advantage may guide rat into trap.

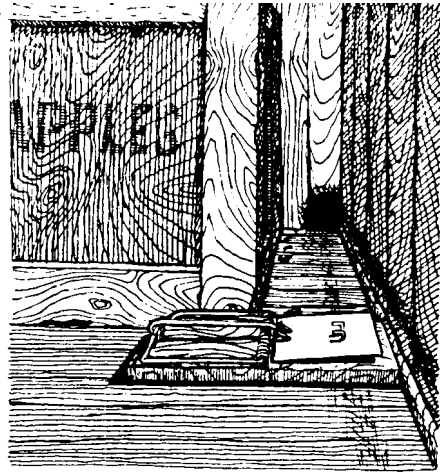

Place traps across obvious runways, or where runs are confined.

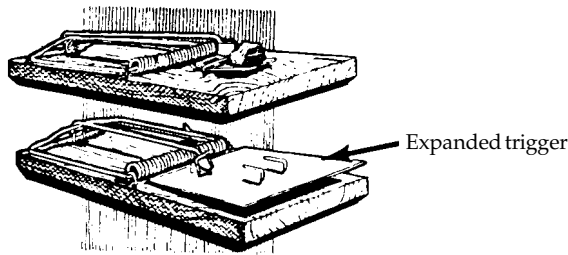

Fig. 19. Expanded-trigger traps, when properly placed, can be very effective.

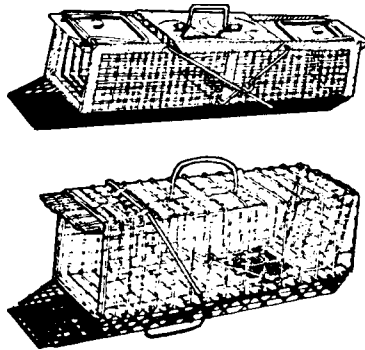

Fig. 20. Wire cage traps can be used to capture rats alive. Use enough traps to make the campaign short and decisive.

In urban and suburban areas, rats may be present because people have pets. It is not uncommon to find rats living in close association with cats and dogs, relying on cat and dog food for nourishment. Rats frequently live beneath dog houses and soon learn they can feed when the dog is absent or asleep.

Economics of Damage and Control

Accurate data on rat damage, control, and their cost is difficult to obtain. Estimates of losses of foodstuffs, structural damage, and the amount of labor and materials expended to control rats are usually only educated guesses. One study found that a small colony of Norway rats (10 to 26 animals), when given access to a ton of sacked wheat, would contaminate 70% of the grain after 12 to 28 weeks. The sacks were heavily damaged as well. Total damage equaled 18.2% of the total value of the wheat and the sacks.

One rat will eat approximately 20 to 40 pounds (9 to 18 kg) of feed per year and probably contaminates 10 times that amount with its urine and droppings. In a year's time, a single rat will produce some 25,000 droppings. A 1973 estimate states rats may cost the United States between \$500 million and \$1 billion annually in direct economic losses. In most cases, the cost of rat control—particularly when it is done in a timely fashion—is far less than the economic loss caused by rat damage.

Acknowledgments

I thank Rex E. Marsh for reviewing this chapter and providing many helpful comments. The material it contains includes information taken from Brooks 1973, Howard and Marsh 1981, and Pratt et al. 1977, among other sources.

Figures 1 and 3 from Schwartz and Schwartz (1981) adapted by Jill Sack Johnson.

Figures 2, 4, 6, 7, 8, 9, 19 and 20 adapted from Pratt et al. (1977) by Jill Sack Johnson.

Figures 5 and 18 adapted from Howard and Marsh (1981) by Jill Sack Johnson.

Figures 10, 11 and 12 by Jill Sack Johnson.

Figures 13, 16 and 17 by Frances I. Gould.

Figures 14 and 15 adapted from Pratt et al., (1977) by Frances I. Gould.

For Additional Information

Brooks, J. E. 1973. A review of commensal rodents and their control. *CRC Critical Reviews in Environ. Control* 3(4):405-453.

Brown, R. Z. 1969. Biological factors in domestic rodent control. *Public Health Service, US Dep. Health, Educ. Welfare, Bull. No. 773*. 32 pp.

Calhoun, J. B. 1962. The ecology and sociobiology of the Norway rat. *Public Health Serv., US Dep. Health, Educ. Welfare, Pub. No. 1008*, 288 pp.

Chitty, D., and H. N. Southern. 1954. *Control of rats and mice*. Vol. 1-3. Clarendon Press, Oxford, U.K.

Davis, D. E. 1981. Environmental control of rodents. Pages 493-498 in D. Pimentel, ed. *CRC Handbook of pest management in agriculture*, Vol. 1. CRC Press, Inc., Boca Raton, Florida.

Elton, C. S. 1953. The use of cats in farm rat control. *British J. An. Behav.* 1:151.

Emlen, J. T., Jr., A. W. Stokes, and D. E. Davis. 1949. Methods for estimating populations of brown rats in urban habitats. *Ecology* 30:430-442.

Emlen, J. T., Jr., A. W. Stokes, and C. P. Winsor. 1948. The rate of recovery of decimated populations of brown rats in nature. *Ecology* 29:133-145.

Fitzwater, W. D. 1982. Bird limes and rat glues — sticky situations. *Proc. Vertebr. Pest Conf.* 10:17-20.

Frantz, S. C. 1976. Rats in the granary. *Nat. Hist.* 85(2):10-21.

Frantz, S. C., and D. E. Davis. 1991. Bionomics and integrated pest management of commensal rodents. Pages 243-313 in J. R. Gorham, ed. *Ecology and management of food-industry pests* FDA tech. Bull. 4, Assoc. Official Analytical Chem. Arlington, Virginia.

Greaves, J. H. 1976. Loss determination by population assessment and estimation procedures. Pages 109-115 in K. L. Harris and C. J. Lindblad, eds. *Postharvest grain loss assessment methods*. Am. Assoc. Cereal Chem.

Gutteridge, N. J. A. 1972. Chemicals in rodent control. *Chem. Soc. Rev.* 1:381-409.

Howard, W. E., and R. E. Marsh. 1981. The rat: its biology and control. *Univ. California Div. Agric. Sci. Pub. No. 2896*. 30 pp.

Huson, L. W., and B. D. Rennison. 1981. Seasonal variability of Norway rat (*Rattus norvegicus*) infestation of agricultural premises. *J. Zool.* 194:257-260.

Jackson, W. B. 1982. Norway rat and allies. Pages 1077-1088 in J. A. Chapman and G. A. Feldhamer, eds. *Wild mammals of North America: biology, management, and economics*. The Johns Hopkins University Press, Baltimore, Maryland.

Jackson, W. B. 1990. Rats and mice. Pages 9-85 in A. Mallis, ed. *Handbook of pest control*. Franzak and Foster Co., Cleveland, Ohio.

Jackson, W. B., and M. Temme. 1976. General considerations, direct measurement techniques, and biological aspects of survey procedures. Pages 101-107 in K. L. Harris and C. J. Lindblad, eds. *Postharvest grain loss assessment methods* Am. Assoc. Cereal Chem.

Jackson, W. B., S. R. Spaulding, R. B. L. Van Lier, and B. A. Dreikorn. 1982. Bromethalin — a promising new rodenticide. *Proc. Vertebr. Pest Conf.* 10:10-16.

Kaukeinen, D. E. 1982. A review of the secondary poisoning hazard potential to wildlife from the use of anticoagulant rodenticides. *Proc. Vertebr. Pest Conf.* 10:151-158.

Kaukeinen, D. E. 1984. Resistance: what we need to know. *Pest Manage.* 3(3):26-30.

Meehan, A. P. 1984. Rats and mice: their biology and control. *Rentokil Ltd., E. Grinstead, U.K.* 383 pp.

Pratt, H. D., B. F. Bjornson, and K. S. Littig. 1977. *Control of domestic rats and mice*. Public Health Serv. US Dep. Health, Educ. Welfare, Pub. No. (CDC) 77-841. 47 pp.

Pratt, H. D., and R. Z. Brown. 1976. Biological factors in domestic rodent control. *Public Health Serv., US Dep. Health, Educ. Welfare, Pub. No. (CDC) 77-8144*. 30 pp.

Rennison, B. D. 1977. Methods of testing rodenticides in the field against rats. *Pesticide Sci.* 8:405-413.

Robbins, R. J. 1980. Taste-aversion learning and its implications for rodent control. *Proc. Vertebr. Pest Conf.* 9:114-121.

Salmon, T. P., and R. E. Marsh. 1979. Age as a factor in rodent susceptibility to rodenticides - a review. Pages 84-98 in J. R. Beck, ed. *Vertebrate pest control and management materials*, ASTM STP 680. Am. Soc. Testing Materials, Philadelphia. 323 pp.

Schwartz, C. W., and E. R. Schwartz. 1981. *The wild mammals of Missouri*, rev. ed. Univ. Missouri Press, Columbia. 356 pp.

Twigg, G. 1975. *The brown rat*. David and Charles, London. 150 pp.

US Department of the Interior. 1959. *Characteristics of common rodenticides*. US Fish Wildl. Serv. Wildl. Leaflet 337. 4 pp.

Weber, W. J. 1982. *Diseases transmitted by rats and mice*. Thomson Pub. Fresno, California. 182 pp.

Editors

Scott E. Hygnstrom
Robert M. Timm
Gary E. Larson